

# IMPULSE <sup>22</sup>

**TOOL PROMOTION / QUALITY MADE BY GEDORE**



**UNIVERSAL SET ALLROUND  
IN TOOL CASE**  
138 pieces

**€367,54**  
+ VAT



**COMBINATION  
SPANNER SET**  
metric

from

**€52,08**  
+ VAT

**10** R3800 3043  
TOOL SET „MEASURING-  
CUTTING-SCREWS“



**4** R4600 3094  
SOCKET SET  
1/4" + 1/2"

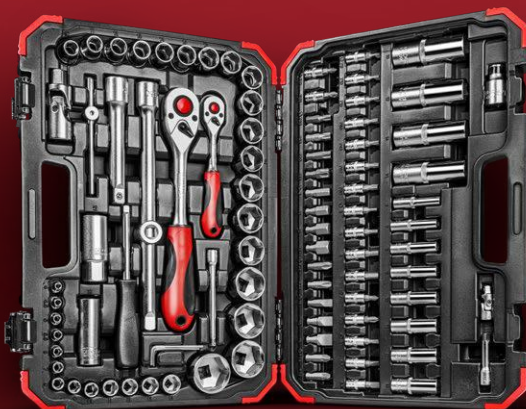

R4600 7138  
UNIVERSAL SET  
ALLROUND  
IN TOOL CASE

**16**



R2015 2006  
WORKSHOP TROLLEY  
MECHANIC

**26**



# HIGHLIGHTS 2022















**30** **R0910 XXXX**  
COMBINATION  
SPANNER SET

**R6890 3011**  
WHEEL MOUNTING SET

**14**



## CONTENTS

	<b>SOCKET SETS</b>	<b>04 – 17</b>
	<b>AUTOMOTIVE</b>	<b>18 / 43 / 45</b>
	<b>RANGE OF SOCKETS</b>	<b>19 – 21 / 24 – 25</b>
	<b>TORQUE WRENCHES</b>	<b>22 – 23</b>
	<b>WORKSHOP EQUIPMENT</b>	<b>26 – 29</b>
	<b>RATCHET SPANNERS</b>	<b>30 – 33</b>
	<b>PLIERS</b>	<b>34 – 37</b>
	<b>1000V</b>	<b>36</b>
	<b>SCREWDRIVERS AND BITS</b>	<b>38 – 39</b>
	<b>STRIKING TOOLS</b>	<b>40 – 42</b>
	<b>MEASURING / MARKING</b>	<b>43 – 44</b>
	<b>CUTTING / FILING / DRILLING</b>	<b>44 – 45</b>

# THE BASIS FOR THE AMBITIOUS SCREWDRIVER

The ratchet all-round carefree package with a wide range

From the small wrench size 4 with the 1/4" ratchet to the 1/2" ratchet and SW 32 - with this socket set from GEDORE red, you are well equipped in every respect for screwdriving work in the workshop. The

fine-toothed ratchets with ergonomic two-component handle are comfortable to use, even over long periods. Sockets from SW 4 - 32 as well as special inserts, for example for spark plugs, and numerous accessories round off the range. All tools are made of chrome vanadium steel and have a satin chrome finish. Nothing slips or dazzles! The tools are clamped in the convenient transport case in GEDORE red design, which is reliably secured with sturdy metal locks.

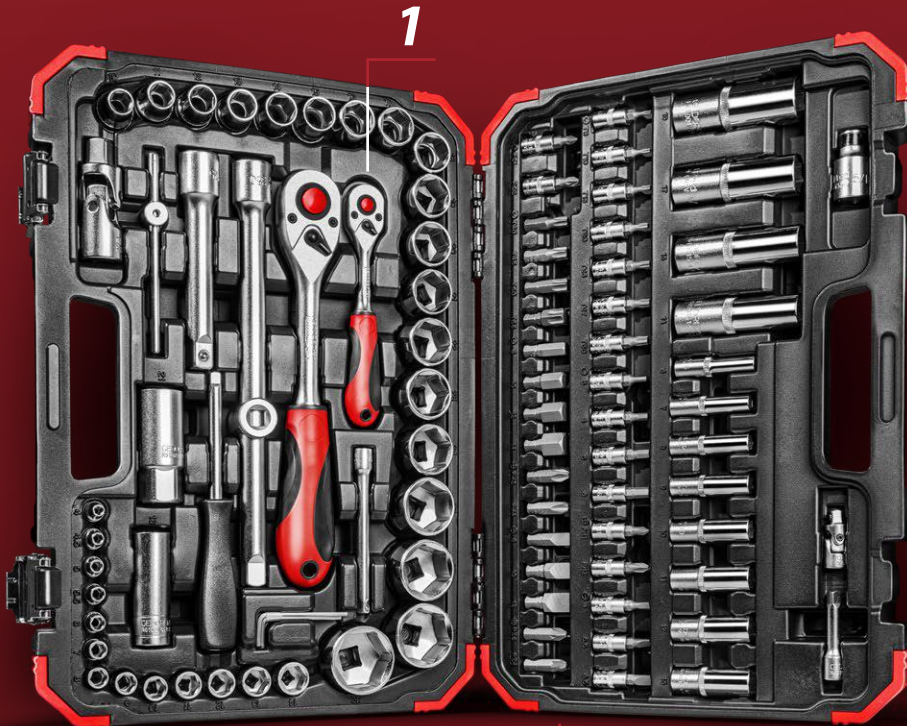

3

2

1

## RATCHETS IN TWO SIZES

- Included in the set are two high-quality fine-toothed lever-action ratchets in sizes 1/4" and 1/2" with ergonomic handle

2

## LARGE RANGE

- The sockets cover the wrench sizes 4 to 32. In addition, there are inserts for other screw profiles.

3

## TOP QUALITY

- All tools are made of chrome vanadium steel and have a glare-free satin chrome finish.



*"This set really contains nuts in all sizes that are needed in everyday life. With the two ratchets in different sizes you are well positioned."*

**R4600 3094**  
**SOCKET SET**  
 1/4" + 1/2"  
 94 pieces

**€83,<sup>99</sup>**  
 + VAT

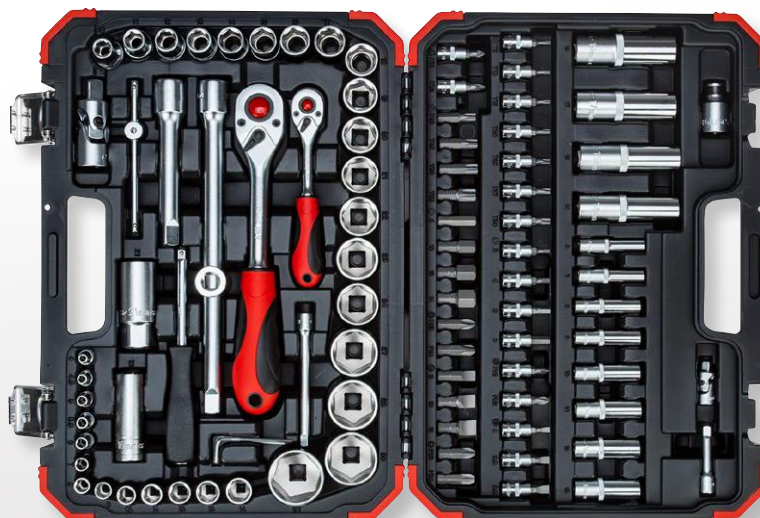

- › For hand-operated screw work
- › Plastic case in GEDORE red design



Code	No.	Contents	Length mm	Width mm	Height mm	Depth mm	Pieces	Weight kg
3300057	R46003094	1/4" 2C lever reversible ratchet, fine-toothed, 72 teeth   150 mm 1/4" square plug-in handle 165 mm 1/4" socket hexagon 4 4.5 5 5.5 6 7 8 9 10 11 12 13 14   25 mm 1/4" socket hexagon 6 7 8 9 10 11 12 13 mm   50 mm 1/4" screwdriver bit socket in-hex 4 4.5 6   37 mm 1/4" screwdriver bit socket slotted 4 5.5 6.5   37 mm 1/4" screwdriver bit socket cross-head PH 1 2   37 mm 1/4" screwdriver bit socket cross-head PZ 1 2   37 mm 1/4" screwdriver bit socket TX T8 T10 T15 T20 T25 T27 T30   37 mm 1/4" socket extension 50 100 mm 1/4" sliding T-bar with slider   115 mm 1/4" universal joint   32 mm 5/16" bits in-hex 8 10 12 14   30 mm, 5/16" bits slotted 8 10 12   30 mm 5/16" bits cross-head PH 3 4   30 mm, 5/16" bits cross-head PZ 3 4   30 mm 5/16" bits TX T40 T45 T50 T55   30 mm 1/2" 2C lever reversible ratchet, fine-toothed, 72 teeth   250 mm 1/2" socket hex 10 11 12 13 14 15 16 17 18 19 20 21 22 23 24 27 28 30 32 1/2" socket hexagon 14 15 17 19   77 mm 1/2" spark plug socket 16 21 mm   65 mm, 1/2" socket extension 125 250 mm, 1/2" universal joint   66 mm Socket extension piece/slider 3/8" x 1/2"   44 mm Bit adapter 1/4" square x 5/16" hex   38 mm Hexagon Allen key set 1.5, 2 2.5 mm	382	285	83	80	94	6,77

**R4900 3033**  
**SOCKET SET 1/4"**  
 33 pieces

**€37,<sup>91</sup>**  
 + VAT

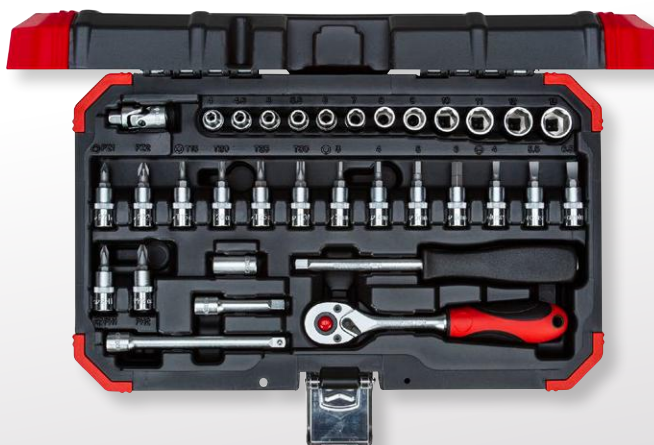

- › For hand-operated screw work
- › Plastic case in GEDORE red design



Code	No.	Contents	Length mm	Width mm	Height mm	Depth mm	Pieces	Weight kg
3300051	R49003033	1/4" 2C lever reversible ratchet, fine-toothed, 72 teeth   150 mm 1/4" square plug-in handle 165 mm 1/4" socket hexagon 4 4.5 5 5.5 6 7 8 9 10 11 12 13 25 mm 1/4" screwdriver bit socket in-hex 3 4 5 6   37 mm 1/4" screwdriver bit socket slotted 4 5.5 6.5   37 mm 1/4" screwdriver bit socket cross-head PH 1 2   37 mm 1/4" screwdriver bit socket cross-head PZ 1 2   37 mm 1/4" screwdriver bit socket TX T15 T20 T25 T30   37 mm 1/4" socket extension 50 100 mm 1/4" universal joint   32 mm Bit adapter 1/4" sq. x 1/4" hex   25 mm	298	185	54	52	33	1,31

**R4600 3097**  
**SOCKET SET**  
 1/4"+1/2"  
 97 pieces

**€137,<sup>11</sup>**  
 + VAT

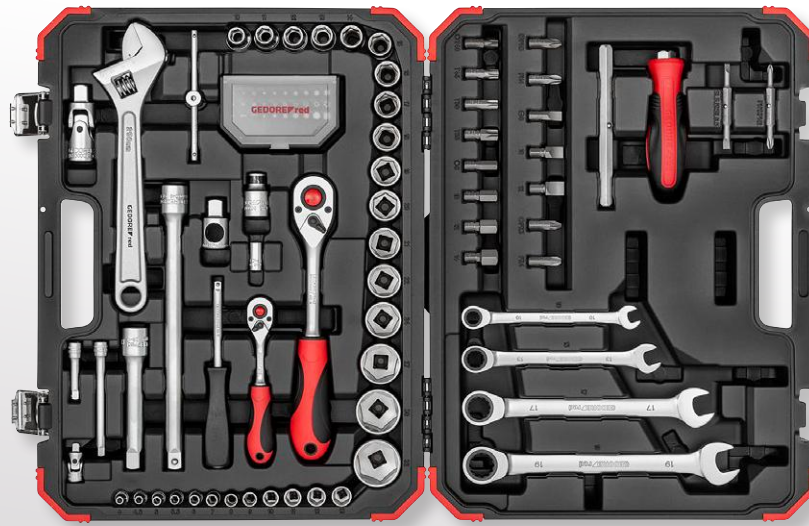

- › For hand-operated work
- › Plastic case in GEDORE red design



Code	No.	Contents	Length mm	Width mm	Height mm	Pieces	Weight kg
3300186	R46003097	1/4" 2K lever reversible ratchet L 150 mm, 1/4" square socket handle L 165 mm 1/4" Socket, hexagonal 4 4.5 5.5 6 7 8 9 10 11 12 13   25 mm 1/4" Cross handle with sliding piece L 115 mm, 1/4" socket wrench extension L 50 100 mm 1/4" universal joint L 33 mm, 1/2" 2K reversible ratchet L 250 mm 1/2" Socket wrench hex 10 11 12 13 14 15 16 17 18 19 20 21 22 24   38 mm 27 30 32   42mm 1/2" socket wrench extension L 125 250 mm, 1/2" universal joint L 66 mm Enlargement adapter/slide 3/8" x 1/2", 1/4" bit adapter, 1/2" bit adapter 1/4" bits, L25mm, inner hex 2 3 4 5 5.5 6 mm, slot 4 5.5 6 mm, PH 1 2 3, PZ 123, TX T10 T15 T20 T25 T27 T30 T40, TXB T10 T15 T20 T25 T27 T30 T40 5/16" bits L30mm, inner hex 8 10 12 14 mm, slot 8 10 12 mm, PH 3 4, PZ 3 4, TX T40 T45 T50 T55 Ring ratchet open-end wrench SW 10 13 17 19 mm 2-component handle Maximus 5/16" shank with bit double blade PH 1 2 bit double blade 5.5 6.5 mm bit adapter 8mm (5/16") x 1/4" Rolling fork wrench, adjustable 30mm, L 250mm	452	340	86	97	8,9

**R4600 3100**  
**SOCKET SET**  
 1/4" + 1/2"  
 100 pieces

**€189,<sup>99</sup>**  
 + VAT

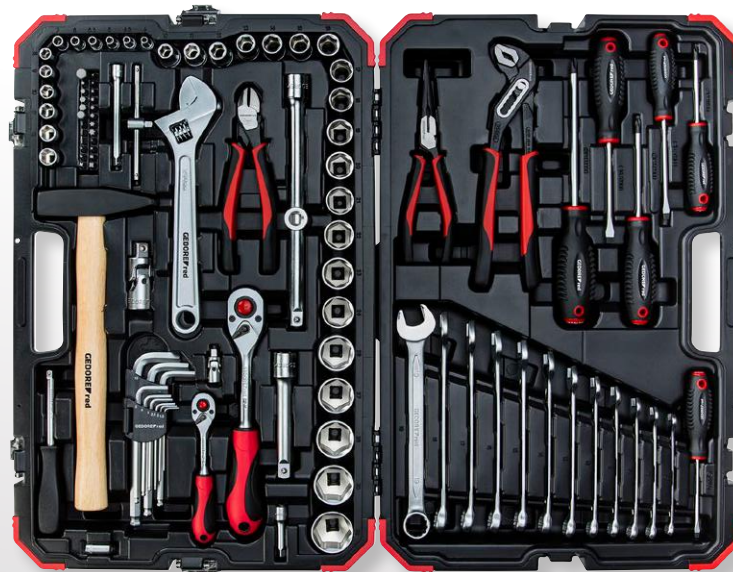

- › Plastic case in GEDORE red design



Code	No.	Contents	Length mm	Width mm	Height mm	Pieces	Weight kg
3300063	R46003100	1/4" 2C lever reversible ratchet, fine-toothed, 72 teeth   150 mm 1/4" square plug-in handle 165 mm, 1/4" socket hexagon 4 4.5 5.5 6 7 8 9 10 11 12 13 mm 1/4" socket extension 50 100 mm, 1/4" sliding T-bar with slider   115 mm 1/4" universal joint   32 mm Bit adapter, 1/4" sq. x 1/4" hex   25 mm 1/4" bits in-hex 3 4 5 6 8 10   25 mm, 1/4" bits slotted 4 5 5 7   25 mm 1/4" bits cross-head PH 1 2 3 4   25 mm, 1/4" bits cross-head PZ 1 2 3   25 mm 1/4" bits TX T8 T10 T15 T20 T25 T27 T30 T40   25 mm 1/2" 2C lever reversible ratchet, fine-toothed, 72 teeth   250 mm 1/2" socket hex 10 11 12 13 14 15 16 17 18 19 20 21 22 23 24 26 27 28 30 32 mm 1/2" socket extension 125 250 mm 1/2" universal joint   65 mm Socket extension piece/slider 3/8" x 1/2"   44 mm Combination spanners 8 9 10 11 12 13 14 15 16 17 18 19 mm Hexagon Allen key set 1.5 2 2.5 3 4 5 6 8 10 mm Adjustable spanner 10" 250 mm, Screwdriver slotted 4 5 5 6 5 Screwdriver cross-head PH 1 2 3, Side cutter 180 mm, Telephone pliers 200 mm, Water pump pliers 10" 250 mm, Hammer 500 g	348	365	105	100	10

**R4600 3232**  
**SOCKET SET**  
**1/4"+1/2"**  
 232 pieces

**€161,<sup>18</sup>**  
 + VAT

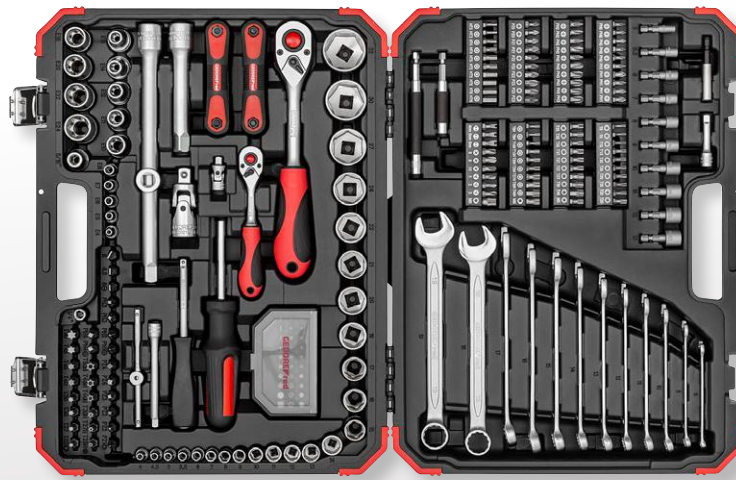

- > hand-operated
- > Plastic case in GEDORE red design



Code	No.	Contents	Length mm	Width mm	Height mm	Pieces	Weight kg
3300185	R46003232	2K reversible ratchet 1/4" length 150mm reverse angle 5° 2K reversible ratchet 1/2" length 250mm reverse angle 5° 1/4" Sockets SW 4 4,5 5,5 6 7 8 9 10 11 12 13 14   25 mm 1/2" sockets SW 15 16 17 19 20 21 22 24   38 mm, 1/2" sockets SW 27 30 32   42 mm 1/4" cross handle with slide, 1/4" socket extension 50 100 mm 1/2" socket wrench extension 125 250 mm, 1/4" universal joint length 33 mm 1/2" universal joint length 66 mm, 1/4" square socket handle 165 mm 1/4" Sockets TX E4 E5 E6 E7 E8   25mm 1/2" Sockets TX E10 E11 E12 E14 E16 E18 E20   38mm, E22 L 40mm, E24 L41mm Enlargement adapter/slide 3/8" x 1/2", 1/2" bit adapter square x 5/16" hex 1/4" bit screwdriver L 100 mm 1/4" bits 25 mm long: inner hex 3 4 5 6  mm, PH each 5x 0 1 2 3, PZ each 2x 0 1 each 3x 2 3, TX T8 T9 T10 T15 T20 T25 T27 T30 T40, , TXB T8 T9 T10 T15 T20 T25 T27 T30 T40, Tensioner 5 6 8, XZN 4 6 8, TRI-WING 1 2 3, Torque 6 8 10 1/4" bits hex 38 mm long 5 5.5 6 7 8 9 10 11 12 13 mm, 1/4" bit holder 60 80 120mm Bit box 30 pcs with 1/4" bits, 25 mm long: inner hex 2 3 4 5 5.5 6 mm, slot 4 5.5 6 mm, PH 1 2 3, PZ 1 2 3, TX T10 T15 5xT20 4xT25 4xT27 T30 T40, TXB T10 T15 T20 T25 T27 T30 T40. 5/16" bits 30 mm long: slot 6 6.5 8, PH 1 2 each 2x3 4, PZ 1 2 each 2x3 4, TX T25 T27 T30 T40 T45 T50, TXB T 25 T27 T30 T40 T45 T50, Ring wrench SW 6 8 10 11 12 13 14 15 16 17 18 19 mm Angled screwdriver hexagon socket 1.5 2 2.5 3 4 5 6 8 mm, Angled screwdriver TX T9 T10 T15 T20 T25 T27 T30 T40 Insert holder 1/4" 4kt x 1/4" 6kt length 25mm	452	340	86	232	8,9

**R5900 3059**  
**SOCKET SET 3/8"**  
 59 pieces

**€80,<sup>53</sup>**  
 + VAT

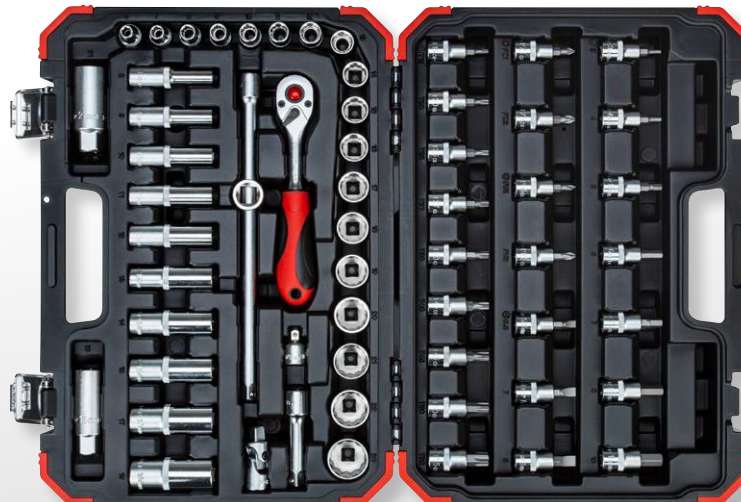

- > hand-operated
- > Plastic case in GEDORE red design

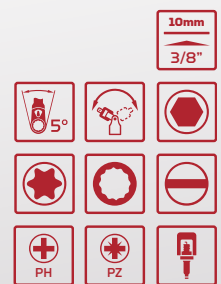

Code	No.	Contents	Length mm	Width mm	Height mm	Depth mm	Pieces	Weight kg
3300054	R59003059	3/8" 2C lever reversible ratchet, fine-toothed, 72 teeth   180 mm 3/8" socket hexagon bi-hex 6 7 8 9 10 11 12 13 14 15 16 17 18 19 20 21 22 24 mm 3/8" socket hexagon hex long 8 9 10 11 12 13 14 15 17 19   L.63mm 3/8" spark plug socket 16 21 mm   65 mm, 3/4" screwdriver bit socket in-hex 3 4 5 6 7 8 10   48 mm 3/4" screwdriver bit socket slotted 5.5 7 8   48 mm 3/8" screwdriver bit socket cross-head PH 1 2   48 mm 3/8" screwdriver bit socket cross-head PZ 1 2   48 mm 3/8" screwdriver bit socket TX T25 T27 T30 T40 T45 T50 T55   48 mm 3/8" socket extension 75 250 mm, 3/8" universal joint   49 mm Reducer 3/8" - 1/4"   27 mm Socket extension piece/slider 3/8" x 1/2"   44 mm	380	280	84	80	59	4,8

**R6900 3069**  
**SOCKET WRENCH**  
**SET 1/2" SERVICE**  
 69 pieces

**€178,47**  
 + VAT

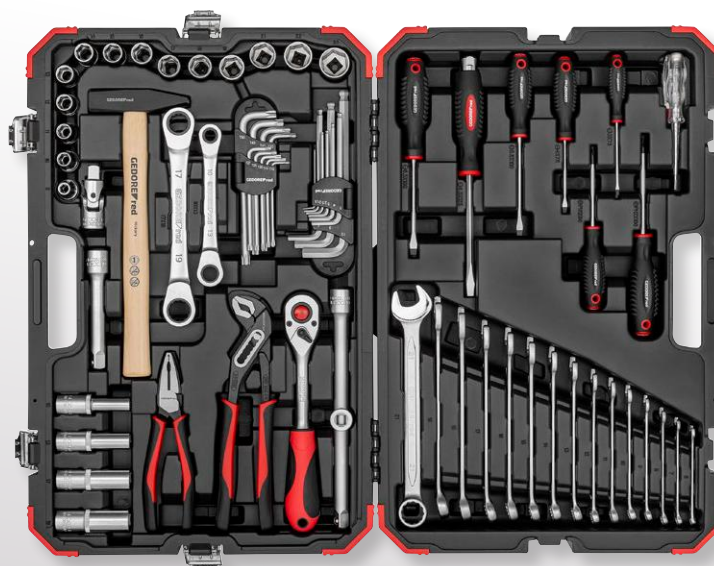

- › For hand-operated work
- › Plastic case in GEDORE red design



Code	No.	Contents	Length mm	Width mm	Height mm	Pieces	Weight kg
3300191	R69003069	1/2" 2K lever-action ratchet fine-toothed, 72 teeth   250 mm 1/2" Socket 6-sided SW 10 11 12 13 14 15 16 17 18 19 21 22 24   38 mm 1/2" Socket 6-sided SW 10 13 17 19   77mm, 1/2" socket wrench extension 125 250 mm 1/2" universal joint   66 mm, Expansion piece 3/8 x 1/2 square   44mm Double ring ratchet wrench SW 10x13 17x19 Ring wrench SW 6 7 8 9 10 11 12 13 14 15 16 17 18 19 21 Angle screwdriver set inside hex SW 1,5 2,2,5 3 4 5 6 8 10 Angle screwdriver set TX T10 T15 T20 T25 T27 T30 T40 T45 T50 Screwdriver slotted 3 4 5,5 6,5, Screwdriver slot with striking cap 6,5 Screwdriver cross recess PH 1 2, Slotted phase tester 120-250 V Combination pliers 180 mm, Water pump pliers 10", Fitter's hammer 300 g	552	360	100	69	9,9

**R6900 3061**  
**SOCKET WRENCH SET 1/2"**  
**AUTO-UNIVERSAL**  
 61 pieces

**€137,11**  
 + VAT



- › For hand-operated screw work
- › Plastic case in GEDORE red design



Code	No.	Contents	Length mm	Width mm	Height mm	Pieces	Weight kg
3300370	R69003061	R6100xxxx Socket insert 1/2 hexagon 8 9 10 11 12 13 14 15 16 17 19 21 22 24 mm R60000027 2K reversible ratchet 1/2 L.250 mm Swing-back angle 5° R65300012 Cardan joint 1/2 L.66 mm R6102xxxx Spark plug insert 1/2 16 18 21 mm R651000xx Plug-in extension 1/2 L.125 250 mm R57300008 Enlargement piece 3/8 x 1/2 square L.44 mm R28100010 Water pump pliers 10" 7-way R28302180 Combination pliers L.180 mm 2K-handle R36605008 Offset screwdriver set hexagonal 1.5-8 mm 8 pcs R36405008 Offset screwdriver set TX T9-40 8 pcs R92100020 Engineer's hammer 500g L.320 mm ash R0910xxxx Combination wrench 6 7 8 9 10 11 12 13 14 15 16 17 18 19 mm R38100315 2C-Screwdriver slot 3 mm 0.5x75 mm, 5.5 mm 1x100 mm, 8 mm 1,2x100 mm R38200115 2C-Screwdriver PH1 L.80 mm, PH2 L.100 mm R38120001 MOTORCYCLE Voltage tester 3-48 V	450	345	93	61	7,14



**R6800 3030**  
**SET OF SCREWDRIVER**  
**INSERTS 1/2" IN**  
 30 pieces

- > For hand-operated work
- > Plastic case in GEDORE red design

**€71,32**  
 + VAT



Code	No.	Contents	Length mm	Width mm	Height mm	Depth mm	Pieces	Weight kg
3301573	R68003030	Screwdriver bit socket in-hex, 5 6 7 8 10 12 14 17 19   55 mm Screwdriver bit socket, in-hex 5 6 7 8 10 11 12 13   100 mm Screwdriver bit socket in-hex 5 6 7 8 10 12 14   140 mm Screwdriver bit socket in-hex, 5 6 7 8 10 12   200 mm	425	325	56	52	30	5,4

**R6800 3026**  
**SET OF SCREWDRIVER**  
**INSERTS 1/2" XZN**  
 26 pieces

- > For hand-operated work
- > Plastic case in GEDORE red design

**€74,77**  
 + VAT



Code	No.	Contents	Length mm	Width mm	Height mm	Depth mm	Pieces	Weight kg
3301574	R68003026	Screwdriver bit socket XZN M5 M6 M8 M9 M10 M12 M14 M16   55 mm screwdriver bit socket XZN M5 M6 M8 M9 M10 M12 M14   100 mm screwdriver bit socket XZN M5 M6 M8 M9 M10 M12 M14   140 mm screwdriver bit socket XZN M8 M10 M12 M14   200 mm	425	325	56	52	26	5,4

# FOR THE SPECIALIST

The set for the finer jobs where accuracy is required

Specially designed for finer work is this GEDORE red tool set. 43 tools and aids for measuring, small screwdriving jobs and repairs are included here. Basic measuring tools such as a rolling tape measure or spirit level combine here with offset screwdrivers and a set of Phillips or slotted screwdrivers to form a coherent tool set for the craftsman on the move. A cutter knife with pocket knife function and three frequently used pliers with ergonomic two-component handles complete this set, which is clamped in the plastic case in GEDORE red design - reliably secured with two sturdy metal fasteners. The optimum supplementary set if a ratchet set with accessories is already available.



3

1

## GRIP

- Flat-head pliers, combination pliers, side cutters - three much-used pliers in the GEDORE red design with ergonomic 2-component handle are included in the set.

2

## HANDILY

- The transport case is robust, yet light and handy. The tool is stored in a clamp-secured manner

3

## PRACTICAL

- The cutter knife is equipped with a pocket knife function. I.e. the blade is retractable - a strong safety feature.



*"For minor repairs, the kit is optimal, especially because it's in such a handy case."*

**R3800 3043**  
**TOOL SET**  
**„MEASURING-CUTTING-SCREWS“**  
 43 pieces

- > hand-operated
- > Plastic case in GEDORE red design

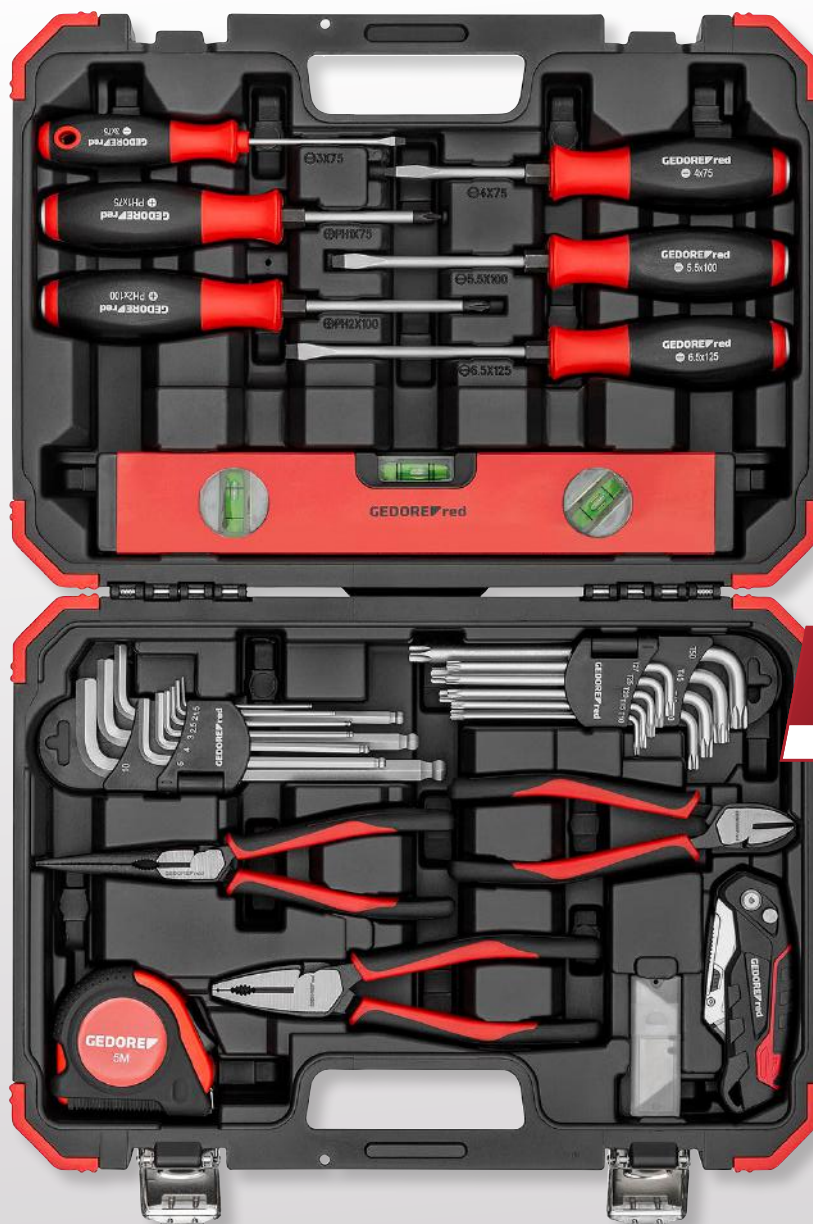

**€97,81**  
 + VAT



Code	No.	Contents	Length mm	Width mm	Height mm	Pieces	Weight kg
3300190	R38003043	Screwdriver slot 3 x 75 mm Screwdriver slot with striking cap 4x75 mm, 5,5x100 mm, 6,5x125 mm Screwdriver cross slot with striking cap PH 1x75 mm, PH 2x100 mm Angle screwdriver set 9 pcs hexagon socket 1,5 2,2,5 3 4 5 6 8 10 long Angle screwdriver set 9 pcs TX T10 T15 T20 T25 T27 T30 T40 T45 T50 Rolling tape measure, 5m Side cutter Flat round nose pliers straight Combination pliers Bubble level 300mm Cutter knife incl. 3 blades 10 spare blades fr cutter knife	383	272	80	43	6,2

**R6800 3032**  
**SET OF SCREWDRIVER SOCKETS**  
 1/2" TX  
 32 pieces

- > For hand-operated work
- > Plastic case in GEDORE red design



**€75,93**  
 + VAT



Code	No.	Contents	Length mm	Width mm	Height mm	Pieces	Weight kg
3301577	R68003032	Screwdriver bit socket TX T20 T25 T27 T30 T40 T45 T50 T55 T60 T70   55 mm Screwdriver bit socket TX T20 T25 T27 T30 T40 T45 T50 T55 T60 T70   100 mm Screwdriver bit socket TX T40 T45 T50 T55 T60 T70   140 mm Screwdriver bit socket TX T40 T45 T50 T55 T60 T70   200 mm	425	325	56	32	5,4

**R3300 5014**  
**BIT BOX 1/4"**  
 14 pieces

- > Bit box with the usual bit sizes and drive adaptor with bit locking
- > Hexagon drive according to DIN 3126 ISO 1173 - C 6.3
- > Machine-operated

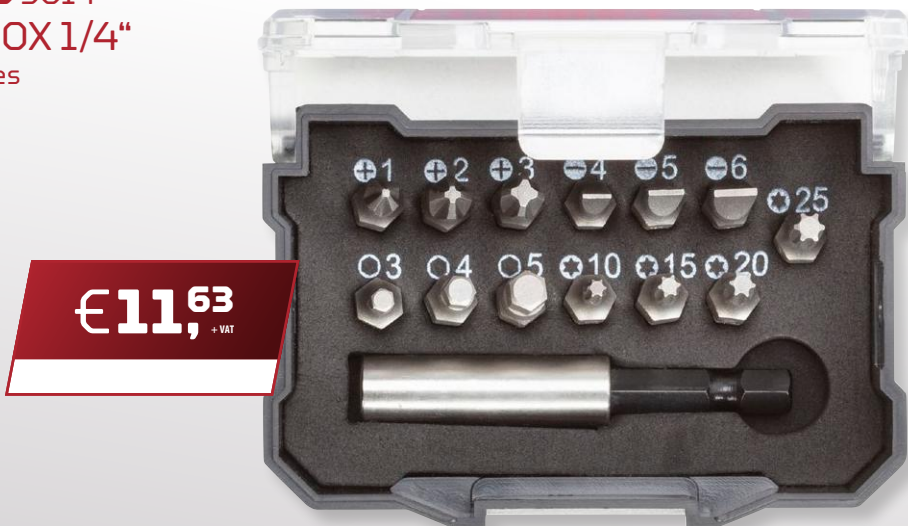

**€11,63**  
 + VAT



Code	No.	Contents	Length mm	Width mm	Height mm	Pieces	Weight kg
3301347	R33005014	1/4" hexagon SW 3 4 5 mm 1/4" slot 4 5 6 mm 1/4" cross recess PH 1 2 3 1/4" TX T10 T15 T20 T25 Bit holder 1/4" hex x 1/4" hex, with magnet	105	60	30	14	0,11

**R4900 5037**  
**TOOL SET T-HANDLE**  
**WITH RATCHET 1/4"**  
 37 pieces

- > In-hex for direct mounting of bits as per DIN 3126 - D 6.3
- > Ring for reversing clockwise/anticlockwise direction
- > 9x long all-steel blades with square drive and sockets
- > 1x long all-steel blade with square drive as bit holder or extension
- > Bits in extra plastic holders



**€44,82**  
+ VAT



Code	No.	Contents	Length mm	Width mm	Height mm	Pieces	Weight kg
3300025	R49005037	2C ratchet hand grip with swivel 1/4" in-hex blade, ring change Socket hexagon 6 7 8 9 10 11 12 13 14 135 mm Bit holder 1/4" hex x 1/4" hex   135 mm 1/4" bit hexagon 3 4 5 6 8 mm   25 mm 1/4" bit slotted 4.5 5.5 6.5   25 mm 1/4" bit cross-head PH 1 2 2 3   25 mm 1/4" bit cross-head PZ 1 2 2 3   25 mm 1/4" bit TX T10 T15 T20 T25 T30 T40   25 mm 1/4" bit TX with drill hole T10 T15 T20 T25   25 mm	240	150	50	37	1,335

**R3892 0000**  
**EXTENDABLE SHANK SCREWDRIVER**  
**13IN1**

- > The perfect all-rounder: 13 screwdriver profiles in the magazine
- > Screwdriver handle with integrated ratchet function, reversible
- > Hex recess drive as per DIN 3126 - D 6.3 (1/4"), for bits
- > Lockable telescopic blade, continuously adjustable
- > Reversible clockwise/anticlockwise ratchet function



**€16,29**  
+ VAT



Code	No.	Content	Drive connector hexagon female inch	Drive connector hexagon female metric	Length mm	variable blade length mm	Weight kg
3301337	R38920000	Magazine screwdriver with 1/4" bits Slot 4 4,5 5,5 mm Cross recess PH 1 2 3, Cross recess PZ 1 2 TX T10 T15 T20 T25 Inside hexagon 4 mm	1/4"	6,3	205	55 - 128	0,28

# EVERYTHING ON BOARD

## High-quality tool set for a wide range of uses

Whether changing wheels in the workshop or at home, the right tools are needed in both cases. The universal wheel fitting set from GEDORE red impresses with its precision and flexibility, and is also an effective solution when things have to move faster.

The 1/2" telescopic ratchet with a lever arm of up to 60 cm makes it easy to loosen tight wheel bolts. The two colour-coded impact wrench sockets with SW 17 and 19 are suitable for common wheel bolts and nuts and are designed for use on impact wrenches. The torque wrench with the torque range 40 - 200 Nm is

designed for cars and vans and scores with an adjusted accuracy of +/- 3 %. Helpful accessories such as a magnetic bowl, chalk and tread depth gauge complete this intelligently assembled set.



## R6890 3011 WHEEL MOUNTING SET 11 pieces

€172,70  
+ VAT



- > The universal wheel mounting set convinces with precision and flexibility and is an effective solution even when things have to be done quickly
- > Plastic case in GEDORE red design



Code	No.	Contents	Length mm	Width mm	Height mm	Pieces	Weight kg
3300400	R68903011	1/2" 2C Telescopic ratchet 460-600 mm, 1/2" Socket wrench extension 75 mm + 125 mm 1/2" Power screwdriver bits, hexagon with protective sleeve 17 mm + 19 mm Tyre tread depth gauge red/black, Magnetic dish, White tyre marking chalk Wheel bolt bag red/black, Blow-moulded storage case (520x280x100mm), Torque wrench 1/2" 40 - 200 N-m	540	290	145	11	5,7

ALL IN

1

**TOUGH IN USE**

- The colour-coded nuts in sizes SW 17 and 19 are also designed for use on impact wrenches.

2

**LONG LEVER ARM**

- The telescopic ratchet can be extended up to 60 cm and thus offers a long lever arm, which is particularly helpful when loosening stuck wheel bolts.

3

**IT DOESN'T GET ANY MORE ACCURATE**

- The torque wrench with a torque range of 40 - 200 Nm offers an adjusted accuracy of +/- 3 %.



*"The set really includes everything needed for a quick wheel change. The nice thing is that the set is housed in a handy case that fits on any shelf."*

**R7800 4014**  
**SOCKET SET 3/4"**  
14 pieces

€229,<sup>28</sup>  
+ VAT



- › For hand-operated screw work
- › Plastic case in GEDORE red design



Code	No.	Contents	Length mm	Width mm	Height mm	Depth mm	Pieces	Weight kg
3300011	R78004014	3/4" reversible ratchet, coarse-cogged, 24 teeth   510 mm 3/4" socket hexagon 22 24 27 30 32 36 38 41 46 50 mm 3/4" socket extensions 200 - 400 mm 3/4" sliding T-bar with slider   460 mm	548	365	105	100	14	14,2

# THE PERFECT ALL-ROUNDER

A comprehensive equipment, clearly arranged and robustly stowed. The tool set makes every craftsman's heart beat faster.

The ALLROUND tool set from GEDORE red is the ideal initial equipment. Whether for installation work, for assembly activities or in the workshop, the tool set offers the right equipment for many areas of work.

From screwdriving tools such as our high-quality ratchets, impact tools, measuring and cutting tools, pliers and VDE tools, this set contains almost everything. The set is rounded off by a sturdy aluminium case.



€367,<sup>54</sup> + VAT

## 1 COMPACTLY STOWED

- The practical intermediate insert allows the extensive tool assortment to be stowed away compactly. Thanks to holders on the side, the clipboard can be fixed for a better overview.

## 2 COMPREHENSIVE EQUIPMENT

- With the 138-piece tool case, you get a comprehensively positioned assortment. The selected products are ideally suited for a wide range of applications, from precision mechanics to assembly.

## 3 HIGH-QUALITY WORKMANSHIP

- The lever-operated reversible ratchets from GEDORE red offer secure fixing of the nut and are manufactured to an extremely high standard, as well as being finely toothed for the smallest possible reversing angle.

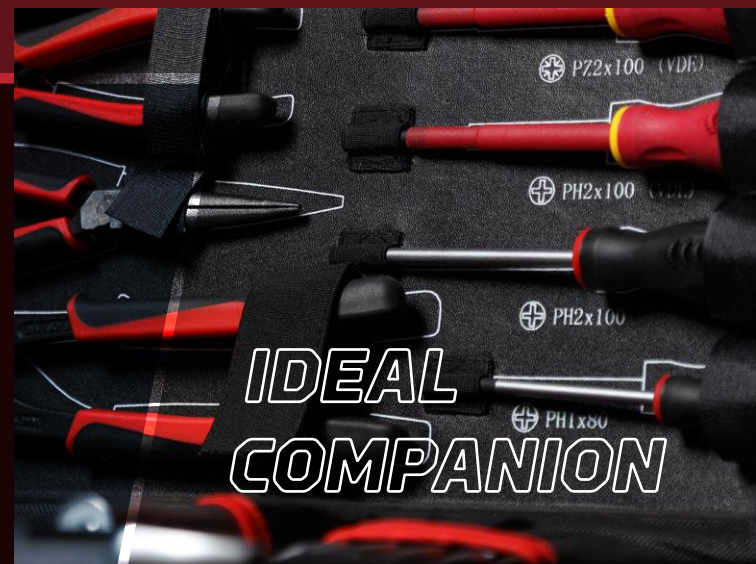

*"The GEDORE red reversible ratchets supplied offer secure fixing of the nut and are finely toothed for the small swing-back angle."*



**R4600 7138**  
**UNIVERSAL SET ALLROUND**  
**IN TOOL CASE**  
 138 pieces

- > hand-operated
- > Aluminium case in GEDORE red design

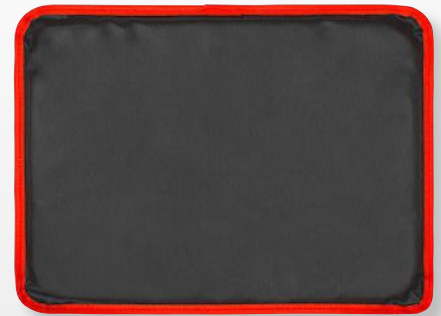

Kneeling board



Code	No.	Contents
3300189	R46007138	2K lever-action ratchet 1/4" fine-toothed, 72 teeth   150 mm 2K lever-action ratchet 1/2" fine toothed, 72 teeth   250 mm 1/4" socket wrench hexagonal SW 4 4.5 5.5 6 7 8 9 10 11 12 13 14   25 mm 1/2" Socket hex SW 10 13 14 16 17 18 19 20 22 24   38 mm 1/2" socket 6-sided SW 27 30 32   42 mm 1/4" socket extensions 50 100 mm 1/2" socket extensions 125 250mm 1/4" square socket handle   165 mm 1/2" spark plug socket SW 16 24   65 mm 1/4" cross handle with slide   115 mm 1/4" universal joint   33 mm 1/2" universal joint   66 mm Drive adapter 1/4" female square x 1/4" hex   25mm Drive adapter 1/4" square x 1/4" hex   50mm Ring wrench SW 8 9 10 11 13 14 17 19 mm Rolled wrench, adjustable 10"   250 mm Angle screwdriver set hex SW 2 2.5 3 4 5 6 8 10 mm Angle screwdriver set TX. long SW T10 T15 T20 T25 T30 T40 T45 T50 Screwdriver slotted 5.5 6.5 8 Screwdriver cross slot PH 1 2 VDE Screwdriver PH 2 PZ 2 Slotted phase tester 120-250 V 1/4" ratchet screwdriver 1/4" Bit box inner hex SW 2 3 4 5 5.5 6 mm, slot 4 5.5 6 mm, PH 1 2 3, PZ 1 2 3, TX T10 T15 T20 T25 T27 T30 T40, TXB T10 T15 T20 T25 T27 T30 T40 Combination pliers 180 mm Side cutter 160 mm Flat round nose pliers 200 mm Water pump pliers 250 mm Crimping pliers and plastic box with accessories 40 tlg. File, half round, cut 2   200 mm LED torch   175 mm Chisel set in plastic holder, 5 pieces Cutter knife with 10 spare blades Hacksaw 150 mm, plus 3 spare blades Fitter's hammer 300 g Rolling tape measure, 5 m Universal scissors, blade length 60 mm Knee board Bar level 300 mm

Length mm	Width mm	Height mm	Pieces	Weight kg
455	355	157	138	13

## R1915 3000 BOLT-EXTRACTOR-SET

14 pieces



- › For slackening and removing bolts and damaged screws
- › Anticlockwise cutting thread with 6 cutting edges tapering together
- › Internal square drive according to DIN 3120 - C 10, ISO 1174, with ball retaining groove
- › Hexagonal outer edges on the inserts

**€139,<sup>71</sup>**  
+ VAT



Code	No.	Contents	Length mm	Width mm	Height mm	Pieces	Weight kg
3301563	R19153000	Boring tool 3/8": 6.4 mm (1/4") 8 mm (5/16") 9.5 mm (3/8") 10 mm 11 mm (7/16") 12 mm 12.7 mm (1/2") 13 mm 14 mm (9/16") 16 mm (5/8") 17 mm 17.5 mm (11/16") 19 mm (3/4") Tapping mandrel 74 mm	190	110	40	14	0,73

## R3800 4006 SCREW REMOVER SET 1/2"

6 pieces

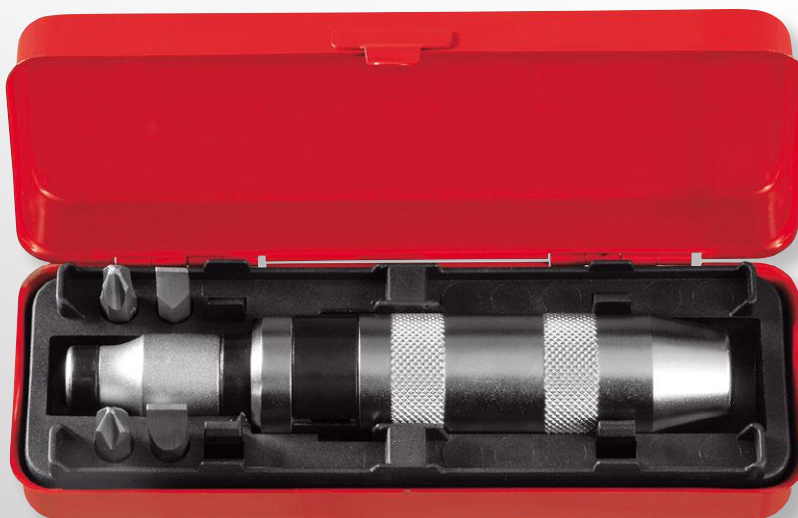

- › Hammer-actuating screw remover for extracting stiff screws!
- › Clockwise/anticlockwise rotating direction, reversible
- › 1/2" square drive in acc. with DIN 3120 - A 12.5, ISO 1174, with ball locking device for sockets
- › 1/2" adaptor, snap-on with hex recess drive in acc. with DIN 3126 - D 8 (5/16") with retention spring for bits
- › In robust sheet metal case

**€31,<sup>58</sup>**  
+ VAT



Code	No.	Contents	Length mm	Width mm	Height mm	Pieces	Weight kg
3301399	R38004006	Bit adapter 1/2" square to 5/16" hexagon socket 5/16" slotted bit 6.8 mm 5/16" cross recess PH 2.3	50	190	60	6	1,022

## R4000 0027 2C-REVERSIBLE RATCHET 1/4"

- > Lever for reversible clockwise/anticlockwise operation
- > Push-button release
- > Fine-toothed
- > 2-component-handle for easy transfer of force
- > For sockets, accessories etc. with square drive as per DIN 3120 - C 6.3, ISO 1174, with ball retention groove



**€22,92**  
+ VAT



Code	No.	Square drive inch	Square drive mm	Return angle	Length mm	Number of teeth	Weight kg
3300158	R40000027	1/4"	6,3	5°	150	72	0,122

## R4012 0027 2C SWIVEL HEAD REVERSIBLE RATCHET 1/4"

- > Ratchet head swivels through 180°
- > Lockable in 5 positions
- > Lever for reversible clockwise/anticlockwise operation
- > Push-button release
- > 2-component-handle for easy transfer of force
- > For sockets, accessories etc. with square drive as per DIN 3120 - C 6.3, ISO 1174, with ball retention groove



**€32,15**  
+ VAT



Code	No.	Square drive inch	Square drive mm	Return angle	Length mm	Number of teeth	Weight kg
3300156	R40120027	1/4"	6,3	5°	165	72	0,13

## R6000 0027 2C-REVERSIBLE RATCHET 1/2"

- > Lever for reversible clockwise/anticlockwise operation
- > Push-button release
- > Fine-toothed
- > 2-component-handle for easy transfer of force
- > For sockets, accessories etc. with square drive as per DIN 3120 - C 6.3, ISO 1174, with ball retention groove



€29,15  
+ VAT



Code	No.	Square drive inch	Square drive mm	Return angle	Length mm	Number of teeth	Weight kg
3300410	R60000027	1/2"	12,5	5°	250	72	0,586

## R6001 0027 2C-TELESCOPIC RATCHET 1/2" reversible

- > Lever for reversible clockwise/anticlockwise operation
- > Push-button release
- > Telescopic shaft can be locked in 5 positions
- > 2-component-handle for easy transfer of force
- > For sockets, accessories etc. with square drive as per DIN 3120 - C 6.3, ISO 1174, with ball retention groove



460 - 600 mm

€37,45  
+ VAT



Code	No.	Square drive inch	Square drive mm	variable length	Return angle	Number of teeth	Weight kg
3300522	R60010027	1/2"	12,5	460-600	5°	72	1,099

## R6060 0006 2C-RATCHET HANDLE WITH COUPLER 1/2"

- > Square coupler for clockwise/anti-clockwise operation
- > Acc. to DIN 3122, ISO 3315
- > 2-component-handle for easy transfer of force
- > Also suitable for use with stepped keys and radiator nipple keys
- > For sockets, accessories etc. with square drive as per DIN 3120 - C 6.3, ISO 1174, with ball retention groove



€20,63  
+ VAT



Code	No.	Square drive inch	Square drive mm	Return angle	Length mm	Number of teeth	Weight kg
3300412	R60600006	1/2"	12,5	12°	272	30	0,56



# PRECISE AS CLOCKWORK

Handy, small torque wrench for applications where maximum accuracy is significantly important.

The handy GEDORE red torque wrench, weighing just 515 g, for the low torque range 5-25 Nm. Particularly of particular interest is the torque wrench, which has a 1/4" square drive with ratchet mechanism, for workshops and mechanics, for example in the car/two-wheel sector. The adjusted accuracy

of this wrench is +/-3%. The torque achieved is clearly audibly and perceptibly signalled. The desired torque is set via the rotary handle. A fixation is possible at the end of the handle via the locking button.



1

## FLEXIBLE IN USE

- Convertible square mushroom head allows controlled right and left tightening

2

## NO SETTLING WHEN TIGHTENING

- The GEDORE red torque wrench has a 1/4" socket with ratchet function.

3

## PRECISE AS CLOCKWORK

- The torque wrench impresses with an adjustment to a triggering accuracy of +/-3%. Test certificate according to DIN EN ISO 6789:2017-2 included

4

## SMALL AND HANDY

- The tool weighs only 515 g with an overall length of just 285 mm.

5

## ADJUSTED IN NO TIME

- The desired torque can be precisely adjusted with the rotary handle. It is fixed at the end of the handle

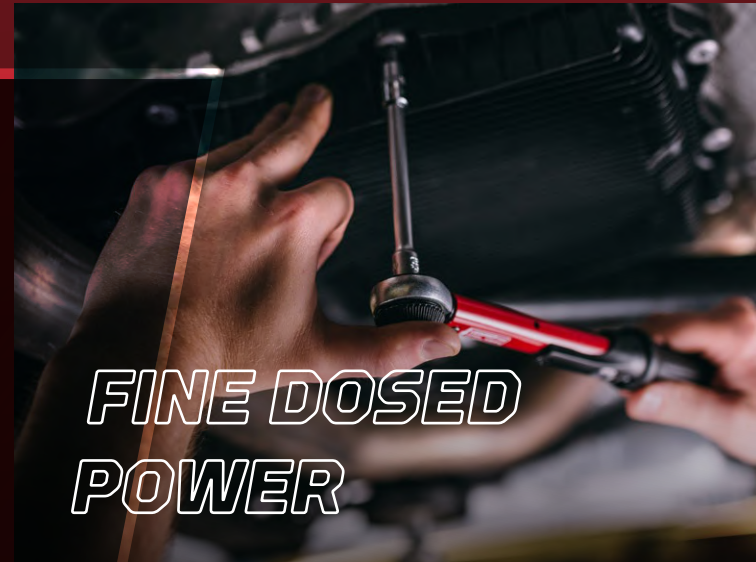

FINE DOSED  
POWER

*"When smaller bolts need to be tightened in a controlled manner, this little torque wrench is really valuable because it is so handy."*



**R4890 0025**  
**TORQUE WRENCH**  
 5-25 N·m

- › Controlled screw tightening from 5 to 25 N · m
- › Audible Torque triggering can clearly be heard and felt
- › Clockwise and anti-clockwise tightening from switching over the mushroom head/push-through square
- › Tripping accuracy: +/-3 % tolerance of the set scale value



Code	No.	Type	Square drive inch	Square drive metric mm	N·m	Nonius	Height mm	Housing - square centre spacing mm	Length mm	Head width mm	Head height mm	Weight kg
3301214	R48900025	square socket with knob, serrated	1/4"	6,3	5-25	1	34	17,5	285	35,0	25,3	0,515

# THE PERFECT TRIO

All common sockets for changing wheels in one set.

Specially designed for installation and removal, this set includes three impact wrench sockets in wrench sizes 17, 19 and 21, covering all common sizes of wheel bolts and nuts. The plastic coating on the 86mm long inserts with 1/2" square socket has two purposes: light metal sweeps in particular are susceptible to scratches due to the

softer material and paint finish. This is avoided by the plastic protection on the nut. In addition, the nuts can be better distinguished by the different colored plastic cover.

€28,<sup>23</sup>  
+ VAT



**R6304 3003**  
**IMPACT SOCKET**  
**SET 1/2"**  
3 pieces



- > Specially for fitting / removing wheels of vehicles
- > Plastic sleeves for damage-free work on aluminium wheel rims
- > Square drive as per DIN 3121 - G 12,5, ISO 1174
- > Acc. to DIN 3129, ISO 2725-2
- > Machine-operated, fixing with safety ring / pin
- > In rugged plastic case



Code	No.	Contents	Length mm	Width mm	Height mm	Pieces	Weight kg
3300578	R63043003	Power wrench insert SW 17 19 21 mm   86 mm	155	135	52	3	0,83



# BRINGING THE FORCE TO THE SCREW

## 1

### TOP MATERIAL

- These nuts will last through thick and thin! Made of chrome molybdenum steel with a phosphated finish, these inserts are designed for long-lasting use on impact wrenches.

## 2

### OPTIMUM COMPOSITION

- Wrench sizes 17, 19 and 21 cover the common sizes for cars and vans.

## 3

### OPTIMUM PROTECTION

- Integrated plastic sleeves protect sensitive components.

## 4

### STURDY STORAGE

- The nuts are stored together in a handy, sturdy plastic box.



*„With this set, you have all the sizes you need for changing wheels. The nuts can be used in a variety of ways - on the ratchet, on the torque wrench and on the impact wrench.“*



**R6300 3008**  
**IMPACT SOCKET**  
**SET 1/2"**  
8 pieces

**€33,41**  
+ VAT

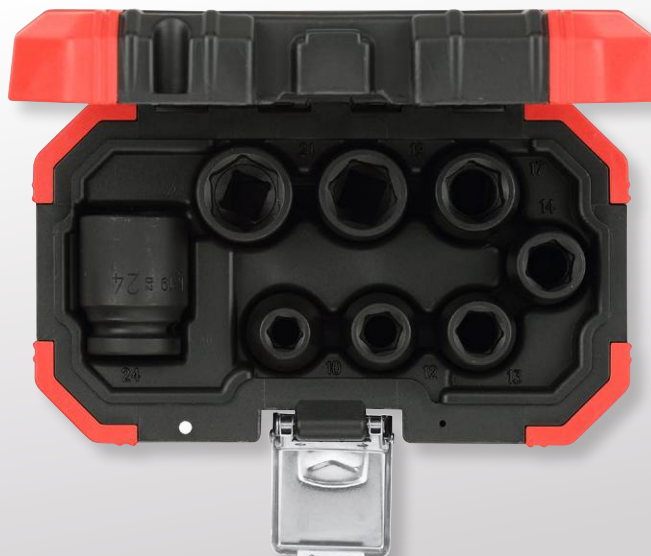

- > Square drive as per DIN 3121 - G 12,5, ISO 1174
- > Acc. to DIN 3129, ISO 2725-2
- > Machine-operated, fixing with safety ring / pin
- > In rugged plastic case



Code	No.	Contents	Length mm	Width mm	Depth mm	Pieces	Weight kg
3300575	R63003008	Impact wrench 10 12 13 14 17 19 21 24 mm	190	110	52	8	1,1

# THE ORGANIZED COMPANION

A lightweight and manoeuvrable workshop trolley with plenty of storage space.

Solid, torsion-resistant, heavy-duty - the MECHANIC tool trolley from GEDORE red is a strong helper at the workstation of the craftsman or ambitious DIY enthusiast. Six drawers that can be variably divided, each with a load capacity of 25 kg, provide ample space for tools and more. Access to the drawer contents is facilitated by the telescopic full-extension runner. Numerous accessories can be attached to the sides of the workshop trolley thanks to the Euro square holes. The central locking, individual locking of the drawers and the external wheels make the MECHANIC a safe companion.



€367,54  
+ VAT

1

## STABLE CONSTRUCTION

- Solid, torsion-resistant sheet steel construction with grease and oil-resistant ABS plastic shelf.

2

## WELL SECURED

- A central locking system with cylinder lock secures tools and equipment from unauthorized access.

3

## SIX DRAWERS

- The drawers offer plenty of space for tools and are fully accessible thanks to the telescopic full-extension runner and feature individual locking.



EVERYTHING  
FITS IN

*„The lightweight and manoeuvrable trolley is a great help in the workplace. Not only does all my tool equipment go in here, the cart is also incredibly variable.“*

## R2015 2006 WORKSHOP TROLLEY MECHANIC

6 drawers, black,  
matt



- > Solid sheet steel construction, torsion-resistant, high load capacity
- > 6 drawers with telescopic full-extension runners with individual locking (one-hand operation)
- > Load capacity 25 kg per drawer, variable partitionable
- > Central locking with cylinder lock with 4 keys



Code	No.	RAL	Height mm	Width mm	Depth mm	Drawers	Max. load-bearing capacity kg	Number of drawers	Weight kg
3300012	R20152006	3020/7016	910	628	418	4 x H = 69 mm 1 x H = 144 mm 1 x H = 218 mm	210	6	56

## R2156 2002 WORKSHOP TROLLEY MECHANIC WITH 6 DRAWERS R20152006 + SET R21010002

in foam modules 166 pieces

- > Solid sheet steel construction, torsion-resistant, high load capacity
- > 6 drawers with telescopic full-extension runners with individual locking (one-hand operation)
- > Load capacity 25 kg per drawer, variable partitionable
- > Central locking with cylinder lock with 4 keys

Detailed listing of the range contents on page 46



Code	No.	Contents	Number of drawers	Pieces	Weight kg
3300013	R21562002	R22150006 1/4" socket wrench set in 1/3 foam module R22150000 Double ring wrench set in 1/3 foam module R22150018 Set of pliers in 1/3 foam module R22150019 Hammer and chisel set in 1/3 foam module R22150009 Socket wrench set 1/2" in 1/3 foam module R22150008 Ratchet with accessories 1/2" in 1/3 foam module R22250001 Combination ratchet wrench set in 2/3 foam module R22150014 Screwdriver set in 1/3 foam module, R22150015 Screwdriver set in 1/3 foam module R22150017 Set of circlip pliers in 1/3 foam module, R27200010 Grip pliers 10". R33005031 Bit-Box 1/4", R38990000 (De)magnetizer R94420021 Caliper gauge, R93200025 Cutter knife with 5-fold blades R94650013 Feeler Gauge Set, 13 pcs. R93160052 Half-round file, R94550003 Tape measure 3 m	6	166	75,24

**R2020 0007**  
**WORKSHOP TROLLEY**  
**WINGMAN**  
 with 7 drawers



- > Solid sheet steel construction, torsion-resistant, high load capacity
- > 7 drawers with telescopic full-extension runners with individual locking (one-hand operation)
- > Load capacity 35 kg per drawer
- > Central locking with cylinder lock with 4 keys

**€609,49** + VAT



Code	No.	RAL	Height mm	Width mm	Depth mm	Drawers	Max. load-bearing capacity kg	Number of drawers	Weight kg
3301690	R20200007	3020 / 7016	1.034	724	470	5 x H = 83 mm 2 x H = 155 mm	450	7	80

**R2207 1004**  
**TOOL SET IN WORKSHOP**  
**TROLLEY WINGMAN**  
 129 pieces



- > Solid sheet steel construction, torsion-resistant, high load capacity
- > 7 drawers with telescopic full-extension runners with individual locking (one-hand operation)
- > Load capacity 35 kg per drawer
- > Central locking with cylinder lock with 4 keys

Detailed listing of the range contents on page 47

**€1081,88** + VAT



Code	No.	RAL	Height mm	Width mm	Depth mm	Contents	Drawers	Max. load-bearing capacity kg	Number of drawers	Pieces	Weight kg
3301694	R22071004	RAL 3020/7016	1.034	724	470	R22350000 Tool set inserts, ratchet, accessories 1/4"-1/2". R22350005 Tool set screwdriver, pliers, hammer, chisel, R22350006 Tool set ring ratchet wrench, double open-end wrench	5x H = 83 mm 2x H = 155 mm	450	7	129	93,64



**R2204 1004**  
**WORKSHOP TROLLEY WINGMAN**  
**WITH TOOL SET**  
 129 pieces



- › Solid sheet steel construction, torsion-resistant, high load capacity
- › 4 drawers telescopically fully extendable with individual locking (one-hand operation)
- › Load capacity 35 kg per drawer
- › Large compartment with 2 lockable hinged doors
- › Central locking with cylinder lock with 2 keys

Detailed listing of the range contents on page 47

**€961,54**  
 + VAT



Code	No.	RAL	Height mm	Width mm	Depth mm	Contents	Drawers	Number of drawers	Pieces	Weight kg
3301689	R22041004	RAL 3020/7016	1.034	724	470	R22350000 Tool set inserts, ratchet, accessories 1/4"-1/2" R22350005 Tool set screwdrivers, pliers, hammer, chisel R22350006 Tool set ring ratchet wrench, double open-end wrench	4x H 83 mm compartment: H 386 x W 612 mm	4	129	81,64

# THE BACKBONE OF ANY TOOL KIT

High quality combination wrench set in commonly used sizes.

Wrenches are the staple for most tradesmen. This 12-piece combination spanner set from GEDORE red is made from chrome-Vanadium steel and chrome-plated with a matt

satin finish for a good grip and glare-free work. The jaw position is inclined by 15°. The set of sizes 10 to 32 mm is supplied in a practical holder, which on the one hand makes it easier to recognise the right size, and on the other hand serves for practical storage.



## 1 COMMON SIZES

- The combination wrench set includes the common sizes from 10 to 32 mm.

## 2 PRACTICAL STORAGE

- The keys are stored in the practical plastic holder. There is immediately noticeable when a key is missing.

## 3 BEST MATERIAL

- The wrenches are made of chrome vanadium steel and have a satin chrome finish.

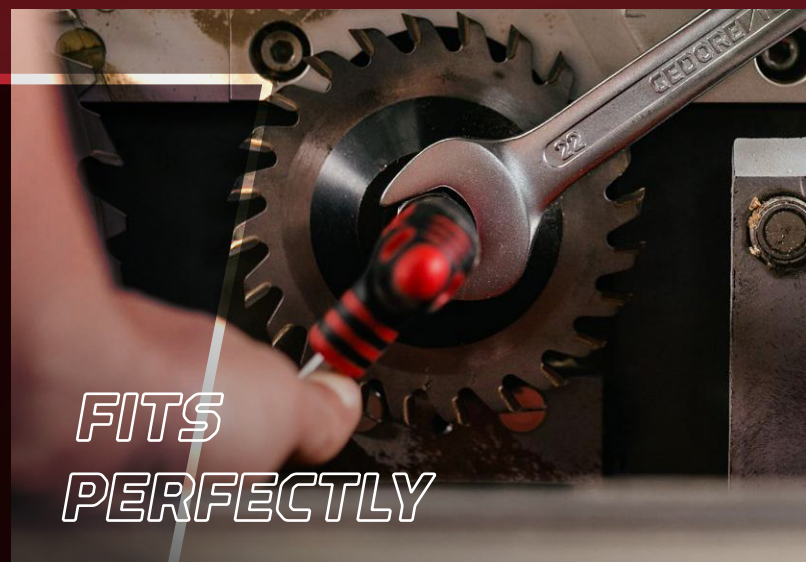

*"I always need combination wrenches at work. The practical set combines all common sizes in itself and is in addition still in the handy holder accommodated. What more could you ask for?"*



**R0910 XXXX**  
**COMBINATION SPANNER SET**  
 metric

- > Acc. to DIN 3113, Form A, ISO 3318, ISO 7738
- > Jaw set at 15°
- > In the holder



Code	No.	Contents	Length mm	Width mm	Depth mm	Pieces	Weight kg	excl. VAT
<b>3300990</b>	R09105012	Combination spanner 10 11 12 13 14 17 1 9 22 24 27 30 32 mm	360	225	65	12	2,5	<b>52,08</b>
<b>3300995</b>	R09105024	Combination spanner 6 7 8 9 10 11 12 13 14 15 16 17 18 19 20 21 22 23 24 26 27 28 30 32 mm	450	360	65	24	5,4	<b>83,30</b>

**R0911 5016**  
COMBINATION  
SPANNER SET  
inch

**€116,83**  
+ VAT



- › Ring offset to 15°
- › Jaw set at 15°
- › In the holder



Code	No.	Contents
3301043	R09115016	Combination spanner 1/4 5/16 3/8 7/16 1/2 9/16 5/8 11/16 3/4 13/16 7/8 15/16 1 1.1/16 1.1/8 1.1/4"

Pieces	Weight kg
16	3,8

**R0110 5012**  
DOUBLE ENDED  
RING SPANNER  
SET  
metric, 12 pieces

**€57,73**  
+ VAT



- › Acc. to DIN 838, ISO 3318, ISO 1085, ISO 10104
- › 5° offset
- › Thin walled rings
- › Chrome-vanadium steel
- › Matt satin chrome-plated finish
- › In the holder



Code	No.	Contents
3300928	R01105012	Double ended ring spanner 6x7 8x9 10x11 12x13 14x15 16x17 18x19 20x22 21x23 24x27 25x28 30x32 mm

Length mm	Width mm	Height mm	Pieces	Weight kg
380	230	46	12	3,55

**R0510 5012**  
DOUBLE OPEN  
ENDED SPANNER  
SET  
long, metric, 12 pieces

**€34,68**  
+ VAT



- › Acc. to DIN 3110, ISO 3318, ISO 1085, ISO 10102
- › Jaw set at 15°
- › In the holder



Code	No.	Contents
3300960	R05105012	Double open-end wrench 6x7 8x9 10x11 12x13 14x15 16x17 18x19 20x22 21x23 24x27 25x28 30x32 mm

Length mm	Width mm	Height mm	Pieces	Weight kg
300	180	66	12	2,42



**R0710 5005**  
**COMBINATION RATCHET**  
**SPANNER SET**  
 metric, 5 parts

**€45,97**  
 + VAT



- > In accordance with DIN 3113 ISO 3318
- > Straight pattern
- > Ratchet mechanism with 72 teeth
- > In the holder



Code	No.	Contents	Length mm	Width mm	Height mm	Pieces	Weight kg
3300849	R07105005	Combination ratchet wrench 8 10 13 17 19 mm	250	180	33	5	0,699

**R0720 5012**  
**COMBINATION RATCHET**  
**SPANNER SET,**  
**REVERSIBLE**  
 12 pieces

**€126,62**  
 + VAT



- > In accordance with DIN 3113 ISO 3318
- > Ring offset to 15°, reversible for right and left hand operation
- > Ratchet mechanism with 72 teeth
- > In the holder



Code	No.	Contents	Length mm	Width mm	Height mm	Pieces	Weight kg
3300873	R07205012	Combination ratchet wrench 8 9 10 11 12 13 14 15 16 17 18 19 mm	320	245	42	12	1,576

**R0750 1002**  
**DOUBLE RING RATCHET**  
**SPANNER SET**  
 2 pieces

**€36,29**  
 + VAT



- > 63 in 2
- > Straight pattern
- > With lever change
- > Ratchet mechanism with 72 teeth



Code	No.	Contents	Pieces	Weight kg
3300900	R07501002	hexagonal/12-edged 5/16 3/8 7/16 1/2 9/16 5/8 11/16 3/4 SPLINE hexagon/12-edge 8 10 11 13 14 16 17 19 mm, TX E10 E12 E14 E16 E18 E20 E22 E24, square 9/32 11/32 3/8 7/16 15/32 17/32 9/16 5/8" - square, square 7 9 11 12 13 14 16 mm	2	0,398

# THE HANDY TRIO

High-quality pliers set for the plumber.

Three professional pliers in one set: the pipe and water pump pliers from GEDORE red feature comfortable handling and high-quality material. The red powder-coated tools made of chrome vanadium steel represent basic equipment for the plumber or the ambitious do-it-yourselfer. The pliers are

designed with a through joint and are used in particular in the trade, industry and automotive sectors, where pipes are fitted or tie rods or axles are repaired.



**€52,71**  
+ VAT

## R2700 0003 PLIERS SET 3 pieces



- > For working on pipes, such as screwing in and unscrewing valves and fastening elements
- > Pipe wrenches R27140015 and R27140020: With S-shaped jaws, ideal for gripping and holding round objects
- > Water pump pliers R28100010: A popular tool for the do-it-yourselfer and the professional craftsman
- > Water pump pliers design according to DIN 8976 form C professional craftsman
- > Pipe wrench design according to DIN 5234

Code	No.	Contents	Pieces	Weight kg
3300040	R27000003	R27140015 Corner pipe wrench, S-shaped jaws, 1.1/2 inch R27140020 Corner pipe wrench, S-shaped jaws, 2 inch R28100010 Water pump pliers, 7-way, 10 inch	3	4,5

# 1

## TOP WORKMANSHIP

- Made of chrome vanadium steel, powder coated red.

# 2

## INTELLIGENT ASSEMBLY

- Two pipe wrenches in different sizes 1.1/2" and 2" provide a good base for the installer.

# 3

## VARIOUS UNIVERSAL TOOL

- The water pump pliers are 7-way adjustable and are used in many trades, especially in the industrial, electrical and automotive sectors.



ALL UNDER  
CONTROL



*"The three pliers are always with me. With them, I can safely grab pipes in many thicknesses."*

### R2710 XXXX PIPE WRENCH Swedish pattern

- > Acc. to DIN 5234
- > Heavy-duty pattern
- > Mouth position 90° angled
- > Teeth offset against direction of rotation
- > Jaws polished
- > Captive adjusting nut
- > Chrome-vanadium steel



€18,<sup>67</sup><sub>+ VAT</sub>

from



Code	No.	Size	Pipe-Ø mm	Length mm	Weight kg	excl.VAT
3301157	R27100010	1"	40	320	0,78	18,67
3301158	R27100015	1.1/2"	55	425	1,356	25,71
3301159	R27100020	2"	67	555	2,55	35,11

## R2720 0010 GRIP WRENCH



€10,49  
+ VAT

- > For clamping and gripping profiled, round and flat-section material
- > Lengthways-serrated grip surfaces
- > With adjusting screw and release lever
- > One-handed operation
- > Chrome-plated surface
- > Chrome-vanadium steel



Code	No.	Total length mm	Total length inch	Clamping reach mm	Weight kg
3301178	R27200010	230	10	40	0,545

## R2720 2003 CURVED JAW LOCKING PLIERS SET

3 pieces

€31,11  
+ VAT



- > For clamping and gripping profiled, round and flat-section material
- > Lengthways-serrated grip surfaces
- > With adjusting screw and release lever
- > One-handed operation
- > Chrome-plated surface
- > Chrome-vanadium steel



Code	No.	Contents	Pieces	Weight kg
3301180	R27202003	7" 10" 12"	3	1,95

## R2910 0010 VDE WATER PUMP PLIERS

€22,36  
+ VAT



- > For tightening and loosening screw connections on e.g. control cabinets
- > Acc. to DIN ISO 8976 Form C
- > Complies with VDE 0682 Part 201 and EN/IEC 60900
- > Lengthways-serrated grip surfaces
- > With box joint



Code	No.	Clamping reach mm	Length mm	Weight kg
3301413	R29100010	39	250	0,393

## R2810 XXXX WATER- PUMP-PLIERS

7 settings

from

€8,80  
+ VAT



- > Acc. to DIN 8976 Form C
- > Lengthways-serrated grip surfaces
- > With box joint
- > 7 settings
- > head and knuckle brightly ground
- > Chrome-vanadium steel
- > Red powder-coated



Code	No.	Clamping reach mm	Length mm	Weight kg	excl. VAT
3301174	R28100007	25	180	0,16	8,80
3301175	R28100010	33	240	0,3	10,56
3301176	R28100012	42	300	0,406	15,27

## R2880 1018 BOLT CUTTER

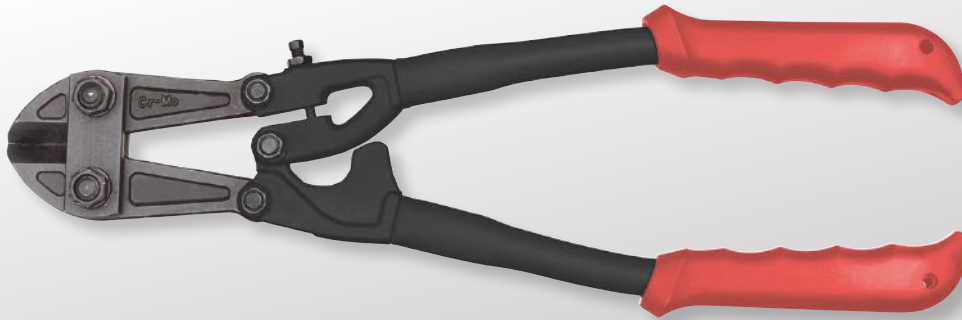

- > Induction-hardened, phosphated precision cutting edges
- > Angled tubular steel leg for ease of use
- > Ergonomically formed 1-component handles
- > Chrome-molybdenum steel

**€38,09**  
+ VAT

Code	No.	Cutting capacity HRC 19 Ø mm	Cutting capacity HRC 40 Ø mm	Total length mm	Weight kg
3301150	R28801018	8	6	450	1,4

## R2892 4112 TOWER PINCER



- > Acc. to DIN ISO 9242
- > head polished
- > Pliers for heavy-duty use
- > Induction-hardened cutting edges
- > Dip-coated handle covers
- > Special tool steel, forged

**€15,98**  
+ VAT

Code	No.	Medium hard wire Ø mm	Total length mm	Weight kg
3301843	R28924112	3,1	300	0,55

## R2820 1165 STRIPPMAX- AUTO WIRE STRIPPER

**€16,80**  
+ VAT



- > Automatic wire stripper for all common flexible and solid conductors from 0.2 - 6.0 mm<sup>2</sup>
- > Smooth running mechanics
- > Simple, intuitive operation
- > Integrated, easily accessible side cutter up to 2 mm Ø
- > Precise work due to optical length gauge (5 - 12 mm)
- > Low weight for fatigue-free work
- > Blades replaceable
- > Comfortable handling due to ergonomic handle geometry
- > Made from glass fibre reinforced polyamide and high quality knife steel from Solingen

**NEW**

Code	No.	Length mm	Cable cross-section mm <sup>2</sup>	Weight kg
3300197	R28201165	165	0,2-6 mm <sup>2</sup>	0,107

**R3801 1005**  
**2C-SCREWDRIVER**  
**MAXIMUS**  
 5 pieces



- > 2-component-handle for easy transfer of force
- > Including bit adapter stowed in the handle
- > Additional 10 mm drive option on the inserted in the shaft bit adapter

Code	No.	Contents	Use		Pieces	Weight kg
3300038	R38011005	2-component handle 5/16" shank Bit double blade PH 1.2 Bit double blade Slot 5.5 6.5 mm Bit adapter 8mm (5/16") x 1/4"	Handle 126 mm Shaft 67 mm Handle with shaft and bit double blade 225 mm		5	0,23

**R3800 2012**  
**SCREWDRIVER**  
**SET XXL**  
 12 pieces



- > Blades of high-grade chrome-molybdenum steel, chrome-plated
- > Moulded handles form a firm unit with the blades
- > 5-edge handle heads stop them rolling off when put down

**€39,74**  
 + VAT



Code	No.	Contents	Pieces	Weight kg
3301273	R38002012	Slotted screwdriver 3 4 5,5 6.5 8 mm Phillips screwdriver PH 1.2 Phillips screwdriver PZ 1.2 VDE slotted screwdriver 2.5 mm VDE Phillips screwdriver PH 1 Phase tester 3 mm	12	0,927



**R3660 5009**  
**HEXAGON**  
**SOCKET KEY SET**  
 in-hex, 9 pieces, short

**€11,60**  
 + VAT



- > Acc. to DIN ISO 2936
- > In the holder



Code	No.	Contents
3301331	R36605009	Size 1.5 2.5 3 4 5 6 8 10

Pieces	Weight kg
9	0,25

**R3850 2005**  
**2C-SOCKET**  
**WRENCH SET**  
 5 pieces

**€25,71**  
 + VAT



- > 2-component-handle for easy transfer of force
- > With hanging hole



Code	No.	Contents
3300033	R38502005	SW 6 7 8 10 13

Pieces	Weight kg
5	0,51

## R9210 XXXX ENGINEERS' HAMMER



- > Drop-forged hammer head, black paint-finished, of heat-treated steel
- > Striking surfaces inductively case-hardened for tough long-term work
- > 360° clamping force of the tapered collar fixes the hammer head

Code	No.	Head weight g	Length mm	Weight kg	excl. VAT
3300710	R92100004	100	260	0,17	7,26
3300711	R92100008	200	280	0,264	7,55
3300712	R92100012	300	300	0,432	8,35
3300713	R92100016	400	310	0,565	8,35
3300714	R92100020	500	320	0,622	10,77
3300715	R92100032	800	350	0,95	11,92
3300716	R92100040	1000	360	1,164	14,41
3300717	R92100055	1500	382	1,72	19,12
3300718	R92100065	2000	400	2,2	21,61

## R9220 XXXX CLUB HAMMER



- > Drop-forged hammer head, black paint-finished, of heat-treated steel
- > Striking surface inductively case-hardened for tough long-term work
- > Acc. to DIN 6474
- > DIN, manufacturer and weight marked for permanence
- > Safety bevel precision-ground to 45° at striking face
- > Double curved ash handle
- > Paint-finished handle end improves the surface feel
- > 360° clamping force of the tapered collar fixes the hammer head

Code	No.	Head weight g	Length mm	Weight kg	excl. VAT
3300725	R92200040	1000	260	1,164	15,27
3300727	R92200055	1500	280	1,69	18,79

## R9240 2024 CARPENTER'S HAMMER



- > Forged type, black paint-finished, from special steel
- > Rounded edges
- > Track with magnetic nail groove
- > Tubular steel handle with plastic grip
- > With head protection

Code	No.	Version/Execution	Head weight g	Head weight oz	Head weight lbs	Length mm	Weight kg
3300784	R92402024	Pein with magnetic nail groove	600	21	1.1/4 lbs	332	0,81





**R9114 0041**  
**FLAT COLD CHISEL**  
 flat oval

€9,63  
 + VAT



- > Acc. to DIN 6453
- > Chrome-vanadium steel
- > Cutting edge and head ground
- > Striking end tempered
- > Shaft copper, tip paint-coated in silver
- > Made from chrome-vanadium steel



Code	No.	Shank height mm	Blade width mm	Length mm	Weight kg
3300789	R91140041	13	25,0	250	0,5

**R9137 0039**  
**SPLITTING CHISEL**  
 flat

€9,39  
 + VAT



- > Cutting edge and head ground
- > Striking ends tempered
- > Shaft copper, tip paint-coated in silver
- > Chrome-vanadium steel



Code	No.	Shank height mm	Blade width mm	Length mm	Weight kg
3300802	R91370039	7	27,0	240	0,26

**R9131 0041**  
**ELECTRICIANS' CHISEL**  
 square

€5,88  
 + VAT



- > For mortising slots, working on masonry, cutting wood and plasterboard
- > Cutting edge and head ground
- > Striking end tempered
- > Shaft copper, tip paint-coated in silver
- > Made from chrome-vanadium steel

Code	No.	Shaft-Ø	Blade width mm	Length mm	Weight kg
3300807	R91310041	8	6,0	250	0,064

## R9190 1004 SET OF PLASTIC CHISELS

4 pieces



- > For the paint-friendly removal of decorative and window strips
- > For removing adhesive weights from aluminum rims
- > Flexible chisel blades
- > Striking cap for light strikes
- > Ergonomic handle
- > Made of special plastic

€23,37  
+ VAT

Code	No.	Contents
3301570	R91901004	Soft chisel 3/4" 19 mm 7/8" 22 mm 1" 26 mm 1.1 / 2" 38 mm

Pieces	Weight kg
4	0,528

## R9000 0006 TOOL SET

6 pieces

€19,84  
+ VAT



- > Striking ends tempered
- > Made from chrome-vanadium steel

Code	No.	Contents
3300826	R90000006	Flat cold chisel- length 125 mm 150 mm, Cross-cut chisel- length 125 mm Drift punch - Ø 3 mm, Centre punch - Ø 4 mm, Pin punch - Ø 4 mm

Length mm	Width mm	Height mm	Pieces	Weight kg
170	110	30	6	0,76



## R9020 0006 PIN PUNCH SET

6 pieces

€19,84  
+ VAT



- > Acc. to DIN 6450
- > Striking ends tempered
- > Made from chrome-vanadium steel

Code	No.	Contents
3300823	R90200006	Pin punch Ø 3 4 5 6 7 8 mm

Length mm	Width mm	Height mm	Pieces	Weight kg
170	110	30	6	0,8



## R9442 0021 DIGITAL MEASURING CALLIPER



- > Large LCD display 30 x 10 mm, with automatic switch-off
- > Resetting possible at any position
- > With mm/inch switching
- > With crossbill
- > Ground beak ends
- > Connection to PC interface

**€42,14**  
+ VAT

Code	No.	Measuring range mm	Measuring range inch	Weight kg
3301430	R94420021	153	6	0,34

## R9410 XXXX SPIRIT LEVEL



- > Smooth square alloy profile
- > One vertical and one horizontal vial, acrylic glass
- > Measurement accuracy: +/- 0.5 mm/m

**€16,31**  
+ VAT

from

Code	No.	Length mm	Weight kg	excl. VAT
3301436	R94100075	600	0,26	16,31
3301423	R94100087	1.000	0,48	18,67

## R9455 XXXX TAPE MEASURE

from **€5,40**  
+ VAT



- > Housing from 2-component ABS, fitted out with metal clip
- > Automatic tape rewind and lock
- > With magnetic stop
- > Accuracy class II with MID certificate

Code	No.	Length m	Tape width mm	Weight kg	excl. VAT
3301427	R94550003	3	19	0,201	5,40
3301428	R94550005	5	19	0,265	8,33
3301429	R94550008	8	25	0,468	9,51

## R9061 0075 TYRE LEVER



**€26,89**  
+ VAT

- > heavy duty pattern
- > Chrome-vanadium

Code	No.	Length mm	Weight kg
3301464	R90610075	610	1,34

**R9090 0020**  
**CARBIDE SCRIBER**  
 with clip



- > Pencil and carbide scriber in one
- > Retractable needle
- > For drawing and marking on metallic and similar surfaces

**€8,57**  
 + VAT

Code	No.	Length mm
3301433	R90900020	150

Weight kg  
0,02

**R9320 0018**  
**UTILITY KNIFE**

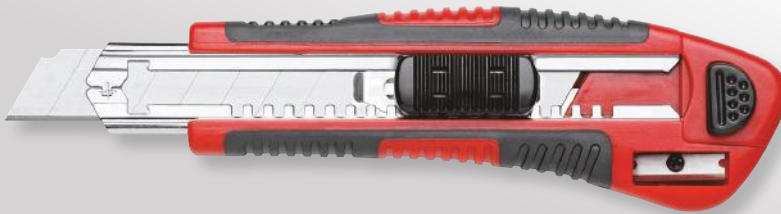

- > Blade 18 mm wide
- > For right-handers
- > Supplied with 5 spare blades (100mm long, 0.4mm thick)
- > With built-in sharpener

**€4,57**  
 + VAT



Code	No.	Designation
3301603	R93200018	Utility knife with 5 blades 18 mm

Total length mm  
170

Total width mm  
50

Weight kg  
0,16

**R9335 0021**  
**HACKSAW**

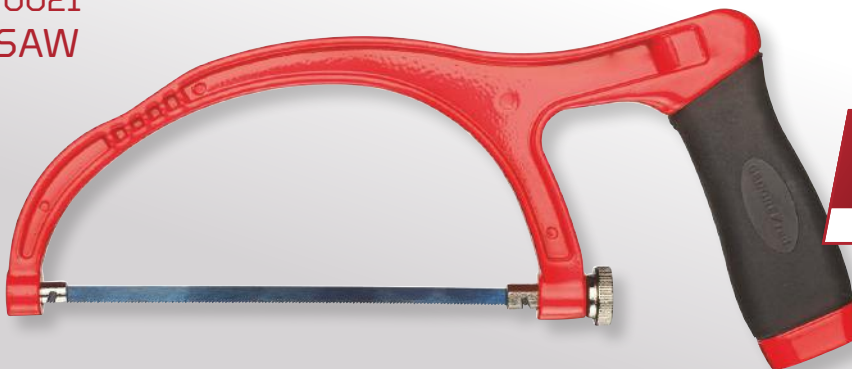

- > Made of aluminium
- > Saw blade for different materials
- > Easy to tension and adjust

**€10,68**  
 + VAT

Code	No.	Designation
3301609	R93350021	Hacksaw

Blade length mm  
150

Weight kg  
0,22

**R9335 0051**  
**MULTIFUNCTION SAW**



- > Saw blade and bow can be turned through 90° = saw blade parallel to the wall and floor
- > Bracket can be rotated 180° = low height, therefore suitable for use in narrow places
- > Supplied with HSS bi-metal saw blade (24 tpi)
- > For metal, plastic, wood, etc.

**€20,07**  
 + VAT



Code	No.	Length mm
3301608	R93350051	300

Weight kg  
0,47

**R9300 0005**  
**FILE KIT**  
5 pieces



- > 2-component-handle, for easy handling
- > Made of special steel
- > In plastic bag

**€25,48**  
+ VAT

Code	No.	Contents
3301597	R93000005	Triangular file, Flat file, Round file, Half-round file, Square file

Pieces	Weight kg
5	0,82

**R1910 1001**  
**HOOK SET**  
4 pieces



- > Assembly / disassembly of O-rings, seals in the field of engine, transmission, steering and hydraulics
- > For working on the interior of the body

**€14,68**  
+ VAT

Code	No.	Length mm
3301548	R19101001	135

Pieces	Weight kg
4	0,114

**R9530 0017**  
**FLASHLIGHT**



**€8,40**  
+ VAT

- > 2 levels of brightness plus warning/signal function
- > 1 W LED
- > Luminous flux 55-60 lm
- > Light range 25-30 m

Code	No.	Length mm
3301755	R95300017	130

Weight kg
0,156

**R9570 0023**  
**WORK LAMP**



**€17,49**  
+ VAT

- > Housing made from ABS plastic
- > Check LED battery display in 5 steps
- > Power source 3.7 v Li-ion battery, 1200 mAh
- > Incl. MICRO USB for charging

Code	No.	Length mm	Height mm	Width mm	Weight kg
3300002	R95700023	155	20	40	0,132

# The individual components at a glance

## R2156 2002

**R2215 0006**



**R2215 0017**



**R2215 0014**



**R2215 0015**



**R2215 0000**



**R2215 0019**



**R2215 0009**

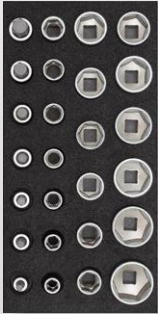

**R2215 0018**



**R2215 0008**



**R2225 0001**



**R3300 5031**



Assortment	No.	Content
<b>R21562002</b>	R22150006	1/4" 2C lever reversible ratchet, fine-tooth, 72 teeth   150 mm, 1/4" square plug-in handle 165 mm 1/4" socket hexagon 4 4.5 5 5.5 6 7 8 9 10 11 12 13, 1/4" screwdriver bit socket in-hex 3 4 5 6 8 10   37 mm 1/4" screwdriver bit socket slotted 5.5 6.5   37 mm, 1/4" screwdriver bit socket cross-slotted PH 1 2 3   37 mm 1/4" screwdriver bit socket cross-head PZ 1 2   37 mm, 1/4" socket TX with hole T10 T15 T20 T25 T27 T30 T40   37 mm 1/4" socket extension 100 mm, 1/4" sliding T-handle with slide   115 mm, 1/4" universal joint   32 mm
	R22150017	Circlip pliers for external retaining rings, straight 19-60 mm, Circlip pliers for external retaining rings, angled 19-60 mm Circlip pliers for internal retaining rings, straight 19-60 mm, Circlip pliers for internal retaining rings, angled 19-60 mm
	R22150014	Screwdriver slotted 4 5.5 6.5 8 mm, Screwdriver cross-slotted PZ 1 2
	R22150015	Screwdriver TX T10 T15 T20 T25 T30 T40
	R22150000	Double-ended ring spanner 6x7 8x9 10x11 12x13 14x15 16x17 18x19 20x22 mm
	R22150019	Engineers' hammer 300 g, Flat cold chisel 125 mm 150 mm, Cross-cut chisel 125 mm Centre punch 4 mm   120 mm, Pin punch 4 mm   120 mm, Drift punch 3 mm   150 mm
	R22150009	1/2" socket hexagon 10 11 12 13 14 15 16 17 18 19 21 22 23 24 26 27 28 30 32 1/2" screwdriver bit socket in-hex 6 7 8 9 10 12 14   55 mm
	R22150018	Water pump pliers 10"   250 mm, Combination pliers 180 mm, Bent nose telephone pliers, straight 160 mm, Side cutter 160 mm
	R22150008	1/2" 2C lever reversible ratchet, fine-tooth, 72 teeth   250 mm, 1/2" socket extension 125 250 mm, 1/2" sliding T bar with slide 250 mm, 1/2" universal joint   66 mm
	R22550001	Ratchet wrench 8 9 10 11 12 13 14 15 16 17 18 19 20 21 22 mm, Hexagon socket key set, 9 pcs, 1.5 2 2.5 3 4 5 6 8 10 mm
	R33005031	1/4" hexagon sizes 3 4 5, 1/4" slotted 0.6x4.5 1.0x5.5 1.2x6.5, 2x 1/4" cross-head PH 1 2 3, 2x 1/4" cross-head PZ 1 2 3 2x TX T10 T15 T20 T25 T30 T40, Quick change adaptor for 1/4" bits C 6.3 with magnet, Bit adaptor 1/4" hex x 1/4" square

## Tools for set completion



**Digital Calipers**



**half-round file**  
310 mm



**Measuring tape**  
3 m



**Grip pliers 10"**  
225 mm



**Cutter Knives**  
with 5 spare blades  
175 mm



**Set of feeler gauges,**  
13-piece



**(Ent-) Magnetizer**

## The individual components at a glance

### R2204 1004 / R2207 1004

#### R2235 0000 SOCKET WRENCH SET 1/4" 1/2" AND ACCESSORIES

in 3/3 foam module, 84 pieces



Assortment	No.	Content
R22041004/ R22071004	R22350000	1/4" 2C lever reversible ratchet, fine-tooth, 72 teeth   150 mm, 1/4" square plug-in handle 165 mm, 1/4" socket hexagon 4 4.5 5 5.5 6 7 8 9 10 11 12 13 14, 1/4" socket hexagon 4 4.5 5 5.5 6 7 8 9 10 11 12 13 50 1/4" screwdriver bit socket in-hex 3 4 5 6 8 10   37 mm, 1/4" screwdriver bit socket slotted 5.5 6.5   37 mm 1/4" screwdriver bit socket cross-slotted PH 1 2 3   37 mm, 1/4" screwdriver bit socket cross-head PZ 1 2   37 mm 1/4" socket TX with hole T10 T15 T20 T25 T27 T30 T40   37 mm, 1/4" socket extension 100 mm 1/4" sliding T-handle with slide   115 mm, 1/4" universal joint   32 mm, 1/2" 2C lever reversible ratchet fine-tooth, 72 teeth   250 mm 1/2" socket hexagon 10 11 12 13 14 15 16 17 18 19 21 22 23 24 26 27 28 30 32 1/2" screwdriver bit socket in-hex 6 7 8 9 10 12 14   55 mm 1/2" spark plug socket 16 21 mm   65 mm, 1/2" socket extension 125 250 mm 1/2" sliding T-handle with slide   250 mm, 1/2" universal joint   66 mm Adjustable spanner 8" 200 mm

#### R2235 0005 SCREWDRIVER, PLIERS, HAMMER, CHISEL SET

in 3/3 foam module, 23 parts



Assortment	No.	Content
R22041004/ R22071004	R22350005	Combination plier 180 mm, Side cutter 160 mm, Bent nose telephone pliers, straight 200 mm, Screwdriver slotted 3 4 5.5 6.5 mm Screwdriver cross-slotted PH 1 2, Screwdriver TX T10 T15 T20 T25 T30 T40, Water pump pliers 10", 250 mm Engineers' hammer 300 g, Flat cold chisel 125 mm, 150 mm Cross-cut chisel 125 mm, Pin punch 4 mm   120 mm Centre punch 4 mm   120 mm, Drift punch 3 mm   150 mm

#### R2235 0006 RING RATCHET AND DOUBLE OPEN-END WRENCH SET

in 3/3 foam module, 22-part



Assortment	No.	Content
R22041004/ R22071004	R22350006	Ratchet wrench 8 9 10 11 12 13 14 15 16 17 18 19 20 22 mm Double open ended spanner 6x7 8x9 10x11 12x13 14x15 16x17 18x19 20x22 mm

# GEDORE

TOOLS FOR LIFE

#### **GEDORE Werkzeugfabrik GmbH & Co. KG**

Remscheider Straße 149  
42899 Remscheid · GERMANY  
Tel. + 49 (0) 21 91- 596 - 0  
Fax + 49 (0) 21 91- 596 - 230  
info@gedore.com  
www.gedore.com

Vertrieb Deutschland  
Tel. + 49 (0) 21 91- 596 - 900  
Fax + 49 (0) 21 91- 596 - 999

#### **GEDORE Automotive GmbH**

Breslauer Straße 41  
78166 Donaueschingen · GERMANY  
Tel. +49 771 83223-0  
Fax +49 771 83223-90

#### **GEDORE Torque Solutions GmbH**

Bertha-Benz-Straße 12  
71665 Vaihingen/Enz · GERMANY  
T +49 7042 9441-0  
F +49 7042 9441-41  
info@loesomat.de

#### **GEDORE AUSTRIA GmbH**

Gedore-Str. 1  
8190 Birkfeld / Strmk. · AUSTRIA  
Tel. +43 (0) 3174 / 363 64 00  
Fax +43 (0) 3174 / 363 83 20  
sales.austria@gedore.com  
www.gedore.at

#### **GEDORE Tools S.A. (Pty) Ltd.**

103 Qashana Khuzwayo (Shepstone) Road,  
New Germany, 3610 - South Africa  
PO Box 68, New Germany, 3620  
SOUTH AFRICA  
Tel. +27 (0) 31 / 705 3587  
Fax +27 (0) 31 / 705 32770  
general@gedoresa.co.za  
www.gedore.co.za

#### **GEDORE IBÉRICA S.L.**

c/Arangutxi 12, Poligono Industrial de Jündiz  
01015 Vitoria Alava · SPAIN  
Tel. +34-945-29 22 62  
Fax +34-945-29 21 99  
gedore@gedore.es  
www.gedore.es

#### **GEDORE UK Limited**

Marion Street, SKIPTON BD23 1TF  
North Yorkshire · UNITED KINGDOM  
Tel. +44 (0) 1756 / 70 67 00  
Fax +44 (0) 1756 / 79 80 83  
sales@gedoreuk.com  
www.gedoreuk.com

#### **GEDORE France SARL**

Parc d'activités des Béthunes - La Mare II  
10, avenue du Fief - Bât. 12  
BP 79144 Saint-Ouen-l'Aumône  
F-95074 Cergy Pontoise Cedex · FRANCE  
Tél. +33 (0)1 34 40 16 60  
Fax +33 (0)1 34 40 16 61  
jadore@gedore.fr  
www.gedore.fr

#### **GEDORE TECHNAG B.V.**

Flemingweg 7, 2408 AV  
Alphen aan den Rijn · NETHERLANDS  
Tel. +31 (0) 172 / 42 73 50  
Fax +31 (0) 172 / 42 73 60  
info@gedore.nl  
www.gedore.nl

#### **GEDORE (INDIA) Private Limited**

148, Sector 3, IMT Manesar  
Gurgaon – 122051  
Haryana · INDIA  
Tel. +91 (0) 124 22910 – 65/66/67  
Fax +91 124 2341067  
sales@gedoreindia.com  
www.gedore.in

#### **GEDORE POLSKA Sp. z o.o.**

ul. Żwirki i Wigury 56a  
43-190 Mikołów · POLAND  
Tel. +48 (0) 32 / 738-40 10  
Fax +48 (0) 32 / 738-40 20  
gedore@gedore.pl  
www.gedore.pl

#### **Ferramentas GEDORE do Brasil S.A.**

Rua Vicentina Maria Fidélis, 275 Bairro  
Vicentina | Vicentina  
São Leopoldo - RS | 93025-340 · BRAZIL  
Tel. +55 51-35 89 9200  
Fax + 55 51-35 89 9222  
export@gedore.com.br  
www.gedore.com.br

#### **GEDORE TOOLS, INC.**

7187 Bryhawke Circle, Suite 700  
NORTH CHARLESTON,  
SC 29418 · USA  
Tel. +1-843/225 50 15  
Fax +1-843/225 50 20  
info@gedorettools.com  
www.gedorettools.com

#### **GEDORE Tool Trading (Shanghai) Co., Ltd.**

1/E., Block 2, 1358 Pingan Road,  
Minhang, Shanghai · CHINA 201109  
Tel. +86-21-3388 7258  
Fax +86-21-3388 7259  
Service Hotline: 400 880 1858  
info@gedore.cn  
www.gedore.cn

#### **GEDORE TOOL CENTER OOO**

4.-ya Magistralnaja H11/1  
123007 Moscow · RUSSIA  
Tel. 8 800 100 58 96 (free from Russia)  
Tel. +7 (499) 754 7000  
Fax +7 (8) 985 22 99 88 0  
sales@gedorettools.ru

Your dealer / stamp:

**Brands of the GEDORE Group**  
gedore.com · ochsenkopf.com

**IMPULSE TOOL PROMOTION** valid  
vom 01/04/2022 bis 31/12/2022.  
While stocks last.

Special net prices per pc./set, plus VAT Delivery without decoration.  
Technical specifications subject to modifications.No liability for printing errors.  
Prices exclude VAT / for resellers only. Please ask your local dealer.

**gedore.com**